

Ziegler Relay Current Protection Relay



True RMS Digital Protection Relay

Ziegler Relay is used to protect against Over Current, Under Current, Current Loss, Current Unbalance.

- ▼ True RMS Measurement
- ▼ Trip relay cum DPM with Class 0.5
- ▼ 4 digit 7 segment LED display
- ▼ 4 different parameters on site selection
- ▼ Stores last 15 faults
- ▼ Configuration via USB-based PRKAB
- ▼ Dual color LED for fault indication
- ▼ Detection of fault with display of parameter value



Applications:

- ▶ Over current
- ▶ Under current
- ▶ Load detection
- ▶ Monitoring of electric heating system
- ▶ General application- for any electrical load, monitoring for under load and over load conditions
- ▶ Motors- monitoring for conditions such as overload, locked rotor and short circuit
- ▶ Genset- to ensure load current is within generator capacity
- ▶ Machinery- detecting broken drive belt on machinery

Product Features:

- ▶ **Over current protection with IDMT curve**
- ▶ **Under current protection**
- ▶ **Current loss protection**
- ▶ **Current unbalance protection**
- ▶ **4 Digits ultra bright Seven segment LED Display**
- ▶ **Trip relay cum DPM with Class 0.5**
- ▶ **True RMS measurement**
The instrument measures distorted waveform up to 15th Harmonic.
- ▶ **Previous fault Storage**
Instrument memorizes the last 15 fault occurred.
- ▶ **LED indications**
 - LED indication for Relay-1 and Relay-2 status .
 - Trip indication are displayed on 4 Digit display.
 - Dual color LED for per phase indication green color for normal condition and Red color for faulty condition.
- ▶ **AND function**
User can use ANDing function to set trip on any two fault condition.
- ▶ **Configuration via USB-based PRKAB**
User can configure the Meter using USB-based PRKAB.
- ▶ **Auto / Manual reset**
In auto mode instrument automatically clears itself. If the device set into manual mode , the device must be manually reset by push button through display if it goes into fault.
- ▶ **User selectable 3 phase 3W or 4W**
User can on site program the network connection as either 1P2W / 3P4W / 3P3W network using front panel keys
- ▶ **Adjustable set point for**
 - Over current
 - Under current
 - Current loss
 - Current Unbalance
- ▶ **Adjustable time delay for**
 - Over current
 - Under current
 - Current loss
 - Current Unbalance
- ▶ **Trip or Buzzer mode**
Relay can be used to protect the system or simply to control the buzzer. Trip mode is for protection purpose and Buzz mode is for buzzer control.
- ▶ **User Selectable CT Secondary**
The input rated current can be programmed on site as 1A to 5A using front panel keys.
- ▶ **Compliance to International Safety standards**
Compliance to International Safety standard IEC 61010-1-

▶ **User selectable CT primary**

The Primary of Current Transformer can be programmed on site from 1 A to 999 kA for Current protection relay.

▶ **EMC Compatibility**

Compliance to International standard IEC 61326 - 1.

▶ **Onsite selection of Auto scroll / Fixed Screen**

User can set the display in auto scrolling mode or fixed screen mode using front panel keys.

ANSI Numbers:

ANSI NO.	Acronyms
37	Under current relay
51	Over current relay
46	Current unbalance relay

Dimensions Details:

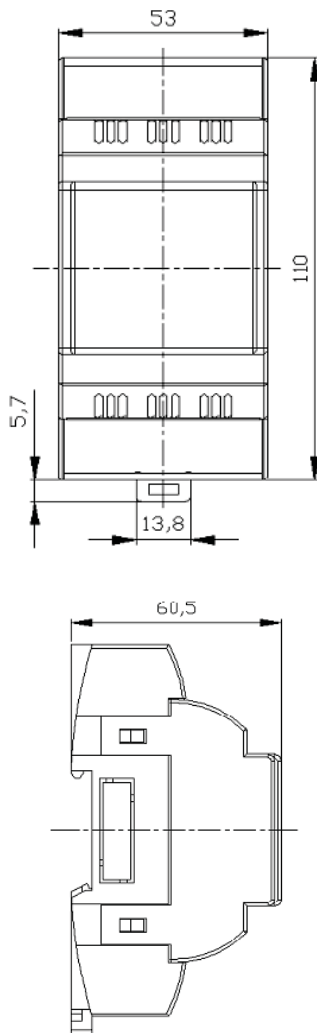

Technical Specifications:

Input Current

Nominal Input Current (AC RMS)	5 A
Max Continuous Input Current	145% of CT Secondary
System CT Secondary Values	1 A to 5 A programmable on site
System CT Primary Values	1 A to 999 kA programmable on site

Auxiliary Supply

Auxiliary Supply Voltage	60 V – 300V AC-DC
Higher Aux Nominal value	230 V AC/DC 50/60 Hz for AC Aux
OR	
External Lower Aux	20 V – 60 VDC / 20 V – 40 VAC
Lower Aux Nominal value	48 VDC / 24 VAC 50/60 Hz for AC Aux
Aux Supply Frequency	45 to 66 Hz range

Overload Withstand

Current	20 x for 1 second, repeated 5 times at 5 min
---------	--

Operating Measuring Ranges

Current Range	5...140% of CT Secondary
Frequency	40...70Hz

VA Burden

Input Current Burden	< 0.25 VA approx. per phase
Auxiliary Supply Burden	< 4 VA approx.

Reference condition for Accuracy

Reference Condition	23°C +/- 2°C
Input waveform	Sinusoidal (distortion factor 0.005)
Input Frequency	50 or 60 Hz ±2%
Auxiliary supply voltage	Nominal Value ±1%
Auxiliary supply frequency	Nominal Value ±1%

Electrical Connection:

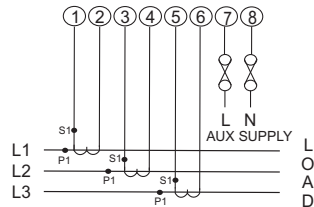

3 Phase 4 wire Unbalanced load

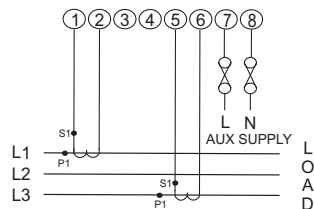

3 Phase 3 wire Unbalanced load

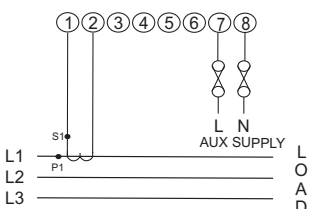

1 Phase 2 Wire

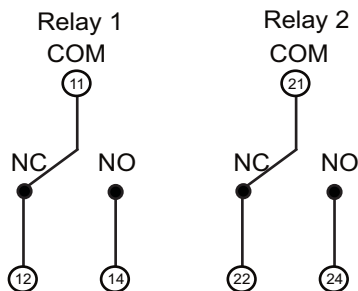

Note- Relay Contacts are shown in power off condition

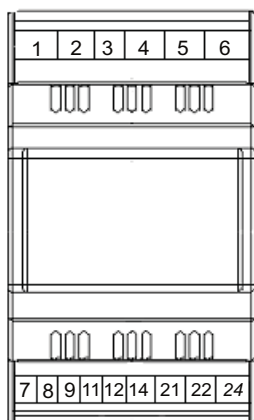

Technical Specifications:

Accuracy

Input Current	±0.5% of nominal value
Frequency	±0.2 Hz
Trip, Reset Delays, Power ON	±140 msec or ±5% of Set Delay, Whichever is Greater (WIG)

Influence of Variations

Temperature coefficient :	0.05%/°C for current
---------------------------	----------------------

Applicable Standards

EMC	IEC 61326 - 1
Immunity	IEC 61000-4-3. 10V/m min – Level 3 industrial Low level
Safety use	IEC 61010-1-2010 , Permanently connected
IP for water & dust	IEC60529
Pollution degree:	2
Installation category:	300V CAT III / 600V CAT II
High Voltage Test	2.2 KV AC, 50Hz for 1 minute between all Electrical circuits.

Environmental

Operating temperature	-10 to +55°C
Storage temperature	-25 to +70°C
Relative humidity	0... 90% non condensing
Shock	15g in 3 planes
Vibration	10... 55 Hz, 0.15mm amplitude
Enclosure	IP20 (front face only)

Relay Contacts

Types of output	1CO, 2CO, 1CO+1CO
Contact Ratings (Res. Load)	5A/250VAC/30VDC
Mechanical Endurance	1x10 ⁷ OPS
Electrical Endurance	NO- 3x10 ⁴ OPS NC- 1x10 ⁴ OPS for 1CO / 1CO+1CO relay 1x10 ⁵ OPS for 2CO relay

Mechanical Attributes

Weight	300g Approx.
--------	--------------

Definite Time Characteristics: Over (OC) and Under (UC) Current

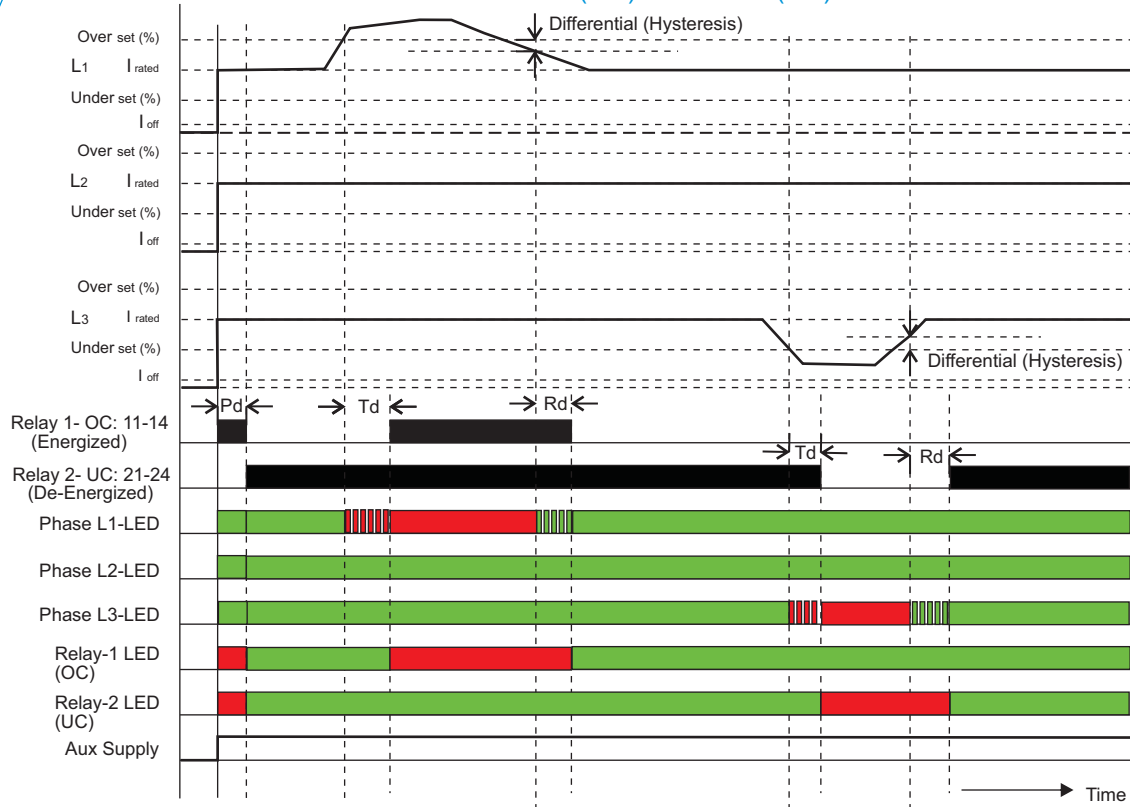

Relay States -

- Energized
- De-Energized

Phase LED Indications -

- Red blinking - Trip Delay (only Phase LEDs)
- Green blinking - Reset Delay (only Phase LEDs)
- RED ON - fault condition
- Green ON - healthy condition
- Input Absent

Relay LED Indications -

- RED ON - fault condition
- Green ON - healthy condition

Note:

- 1) Pd - Power ON delay
- 2) Td - Trip delay
- 3) Rd - Reset delay
- 4) Both relay can be configured to energize or de-energize mode
- 5) Any relay can be assigned to any fault condition

Current Loss (C.LoS) and Current Unbalance (C.un)

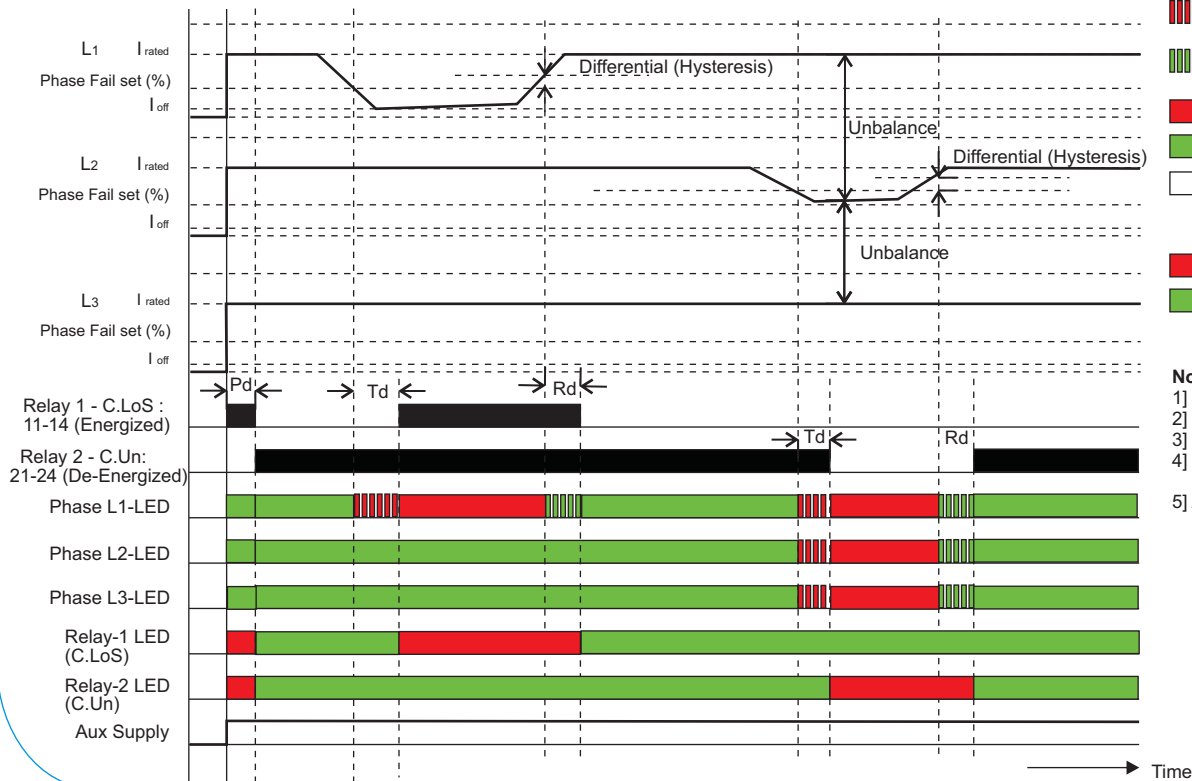

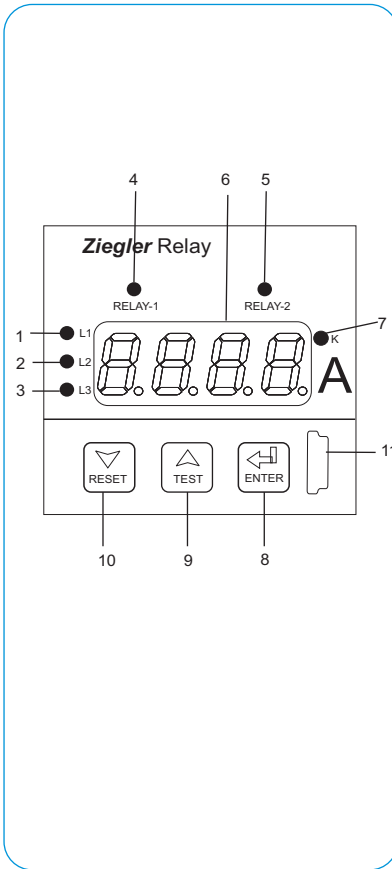

Operating elements:

- 1 - L1- LED : Indicates status of I1 . It Lights green when input current is healthy, red in fault condition, red blinking in trip delay and green blinking in reset delay.
- 2 - L2-LED : Indicates status of I2. It Lights green when input current is healthy, red in fault condition, red blinking in trip delay and green blinking in reset delay.
- 3 - L3- LED : Indicates status of I3. It Lights green when input current is healthy, red in fault condition, red blinking in trip delay and green blinking in reset delay.
- 4/5 - Relay-1 and Relay-2 status LED : Indicates status of relay-1 and relay-2 respectively. It lights green for relay in healthy condition and red for relay in trip condition.
- 6 - 4 Digit ultra bright 7 seg LED Display.
- 7 - K LED : It is used to show value in kA.
- 8 - Enter Key : Confirms changes of parameter setting. When on the measurement screen, holding for 3 sec enters in setup menu.
- 9- Test Key : Increments setting value, move upwards in the menu or change parameter. It is also used to test operation of relay. Continuous holding of test key changes relay position and when release it resets the relay position (Only in healthy condition).
- 10- Reset Key : Decrements setting value, move downwards in the menu or change parameter. It is also used to reset relay when manual reset mode is selected.
- 11- Configuration via USB-based PRKAB.

Parameter Settings:

Parameters	Ziegler Relay-I
Trip setting for Current loss	5 - 99%
Trip setting for Current Unbalance	2 - 20%
Trip setting for over current (IDMT Disabled)	101 - 140%
Trip setting for over current (IDMT Enabled)	101 - 125%
Trip setting for under current	10 - 99%
Setting for Differential / hysteresis	1 - 15%*
Time Multiplier Setting (TMS)	0.1 - 1
Individual Faults can be deactivated as per system requirement	YES
Relay control mode	De-energize / Energize
Reset Delay	0.2 - 30s
Programmable Delay for over current	0 - 30s
Programmable Delay for under current	0 - 30s
Programmable Delay for Current loss	0 - 30s
Programmable Delay for current unbalance	0 - 30s
Power ON Delay	0.5 - 30s
CT primary current	1 A - 999 kA
Rated current	1 to 5 A
Reset option	Auto / Manual

Note * Differential setting range for current unbalance is limited as per its setting of trip point.

Hysteresis Calculation Method:

Example: -

For "OC" (Over Current)
 CT Secondary = 5 A
 Trip point = 101% of CT Secondary = 5.05 A
 Hysteresis = 2% of CT Secondary = 0.1 A
 Relay Reset point = Trip point - Hysteresis
 = 5.05 - 0.1
 = 4.95 A

Example: -

For "C.un" (Current Unbalance)
 CT Secondary = 5 A
 Trip point = 10% of CT Secondary = 0.5 A
 Hysteresis = 2% of CT Secondary = 0.1 A
 Relay Reset point = Trip point - Hysteresis
 = 0.5 - 0.1
 = 0.4 A

Inverse Characteristics Curve [Over Current IDMT]:

Relay Characteristics type	α	C
Standard Inverse	0.02	0.14
Very Inverse	1	13.5
Extremely Inverse	2	80
Long Inverse	1	120

To Calculate Relay Operating Time when IDMT is enabled, use the following formula

$$T = \frac{C}{\left(\frac{I}{I_s}\right)^\alpha - 1} \times TMS$$

Where,

T = Time in Sec (Operating time of relay).

I = Input Current.

I_s = Secondary Current.

TMS = Time Multiplier Setting.

C = Constant for relay characteristics.

α = Constant representing inverse time type
 ($\alpha > 0$)

Ordering Information:

Ordering information	Ordering Code Ziegler Relay I
System Type	
Single Phase	1
Three Phase (On-site programmable to 1P2W / 3P4W / 3P3W)	3
Relay type of outputs	
1CO+1CO	2001
1CO	2000
2CO	2002
Auxiliary Supply Voltage	
60 - 300 V AC/DC	HA
20 - 60 VDC / 20 - 40 VAC	LA

Order Code Example:

1. Ziegler Relay I - 1 - 2001 - HA:

Ziegler Current Protection Relay, Single Phase, Relay contact 1CO+1CO, External Aux 60-300 V AC/DC.

2. Ziegler Relay I - 3 - 2002 - LA:

Ziegler Current Protection Relay, Three Phase, Relay contact 2CO, External Aux 20-60 VDC / 20-40 VAC.

ZIEGLER INSTRUMENTS

Schnepfenreuther Weg 6, D-90425 Nürnberg, Germany.

TEL.	(+49)(911) 38 492 45	E-MAIL	info@ziegler-instruments.com
FAX.	(+49)(911) 32 26 212	WEBSITE	www.ziegler-instruments.com



Ziegler

Redefine Innovative Metering

